

1		
Description	Material	Finish
Body	Brass	Nickel
Socket	BE CU	Gold
Insulation	Teflon	Teflon
Nut	Brass	Nickel
Washer	Brass	Nickel

SIDE VIEW

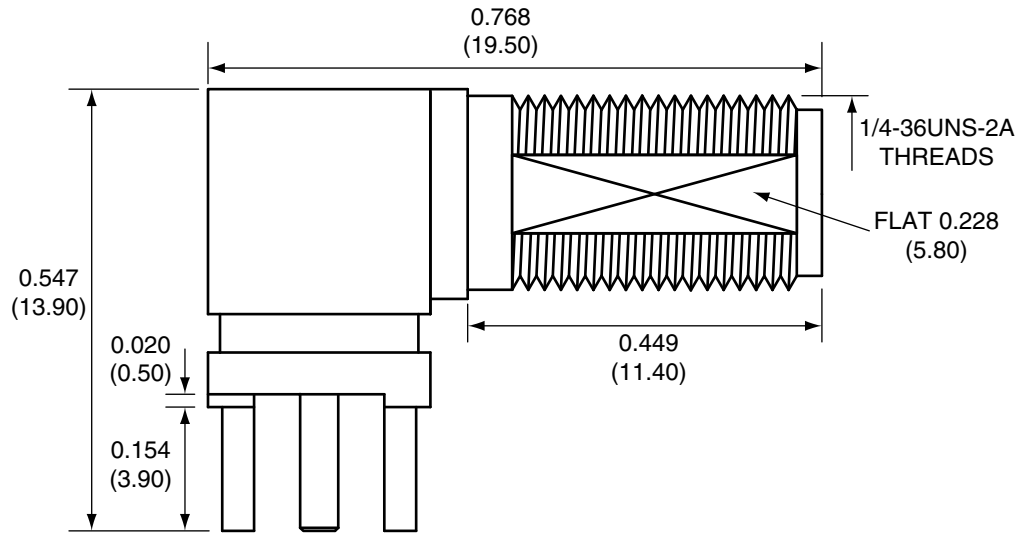

BACK VIEW

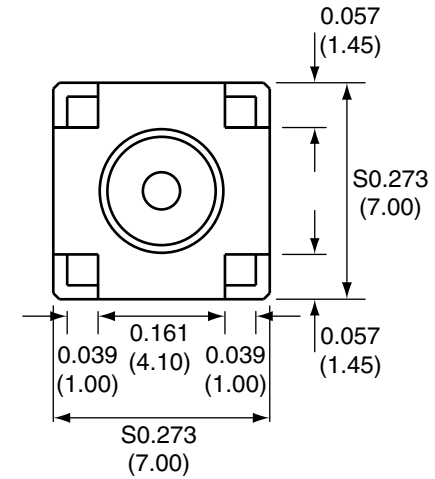

RECOMMENDED MOUNTING HOLE

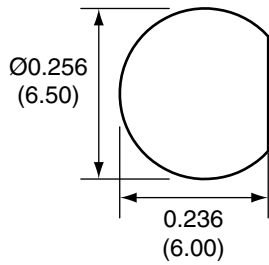

RECOMMENDED FOOTPRINT

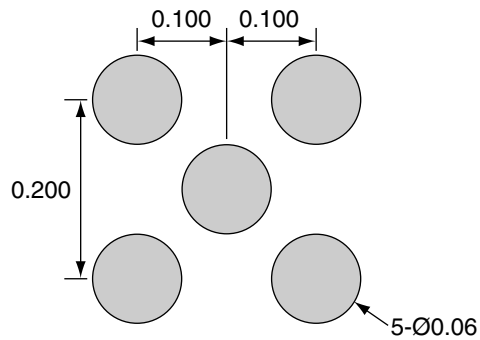

WASHER

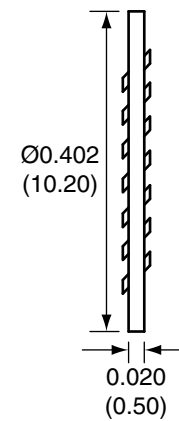

NUT

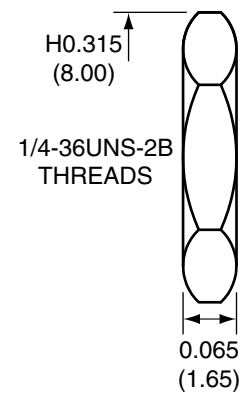

Title SMA FEMALE RIGHT ANGLE PCB MOUNT, EXTENDED		CONNECTOR CITY 159 ORT LANE MERLIN, OR 97532 PH (541)-471-6256 FAX (541)-471-6251	
Part No.	CON SMA002-L	Revision:	1.0
Dimensions:	INCHES (mm)	Date:	5/21/2007